

SENSOFAR

MEDICAL

System for assisted
inspection of stents

In-line Inspection | Process Development | QA | R&D

Q

six

Optical Stent Inspection

Outstanding solution for in-line inspection

Be fast, feel safe

The Q six has been designed as a comprehensive solution for simplifying and streamlining stent assessment and approval. High-resolution imaging and 3D optical measurement allow for complete surface inspection of the stent structure, reducing errors, quality control costs, and inspection time, making the task of acceptance faster, easier and more reliable.

SENSOFAR

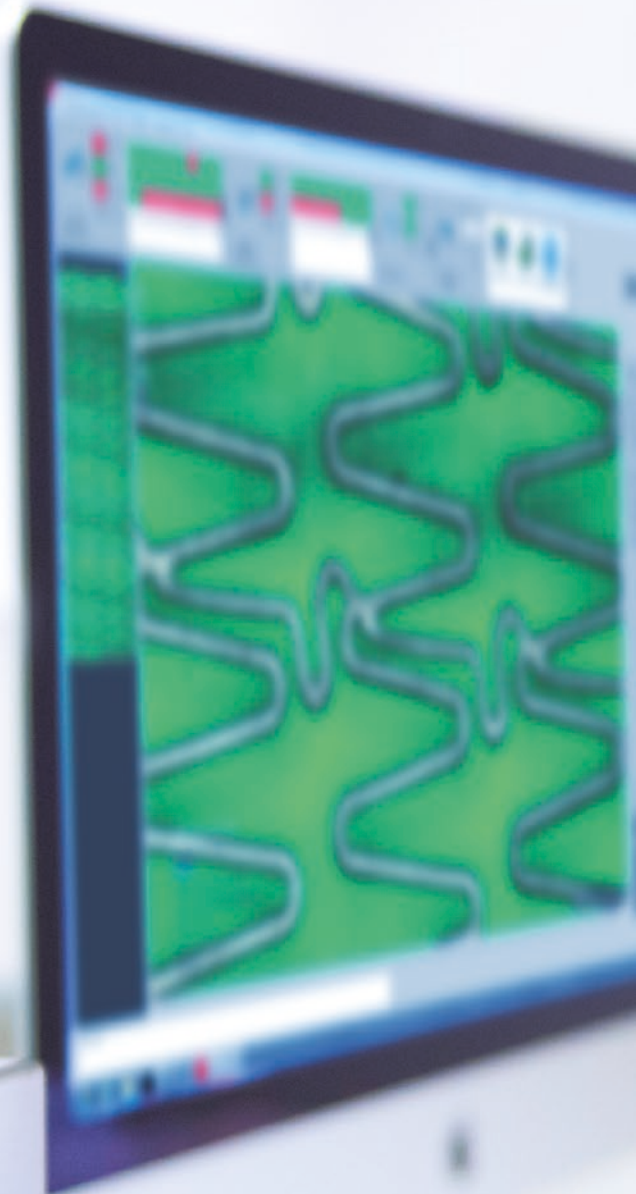

Assisted concept

Quality decisions

The proprietary SensoINSPECT software of the Q six was designed for versatility. The manual mode is designed for flexibility in R&D and Process Development, while the assisted mode is the optimal solution for fast in-line inspection. Dimensional pass/fail data and classified defect information can be gathered in a short time, enabling the operator to make a fast and reliable decision to either accept or reject the stent. After this decision is made, the system will automatically transfer the Stent Inspection Results to the Production ERP. Easy implementation of the Q six within QA and production environments is facilitated by the SensoINSPECT assisted approach.

High performance

Immediate results

The Q six is able to simultaneously acquire and analyze images of the outer and inner surfaces as well as the sidewalls of the stent structure at a rate ranging from 5 mm²/s to 20 mm²/s. SensoINSPECT is compliant with 21CFR Part 11 requirements.

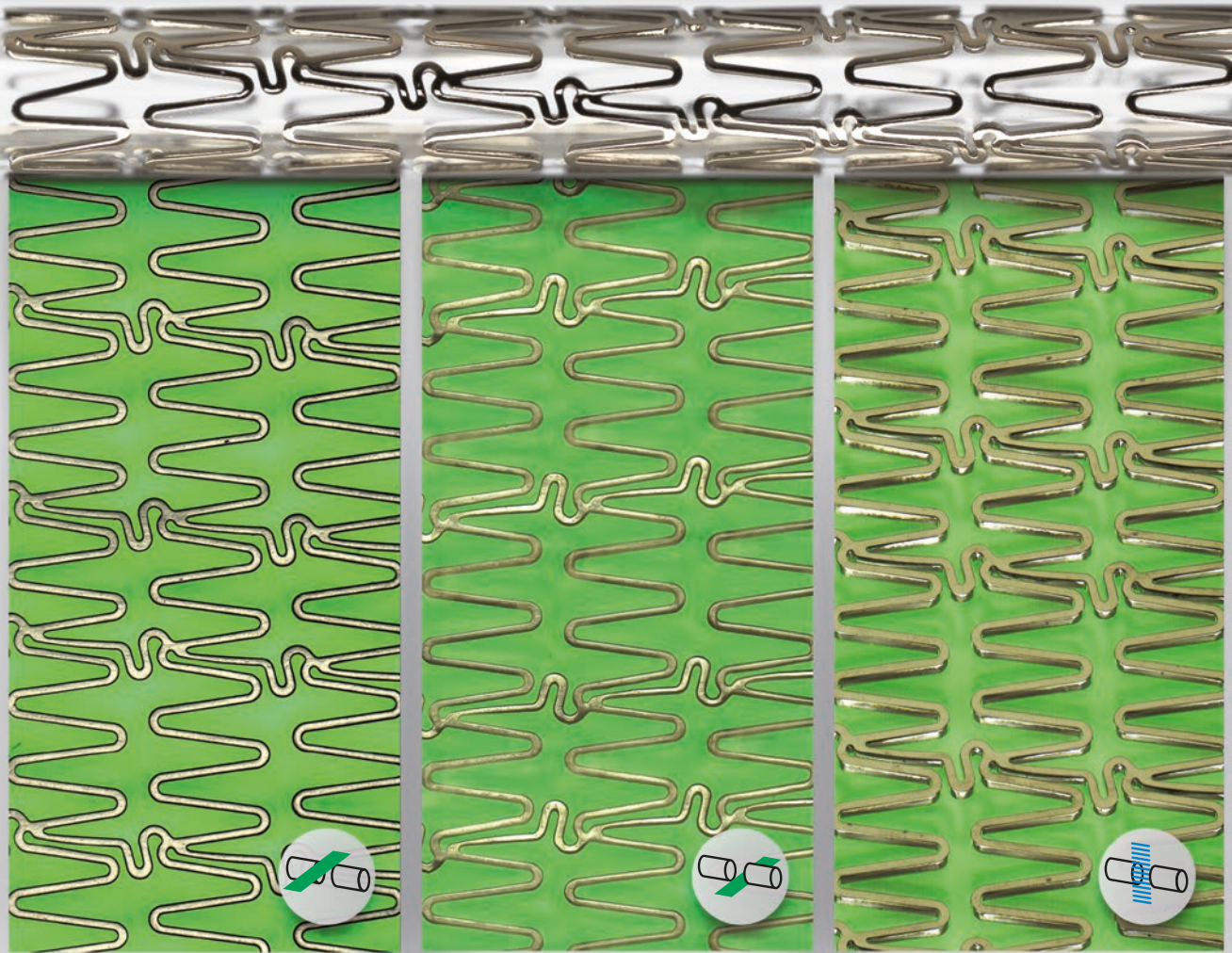

Outer surface view

Inner surface view

Sidewalls view

Complete surface inspection

Unroll your view

Never before seen, high-quality unrolled images of the outer and inner surfaces and the sidewalls of stents. Quality of edges can be also assessed from these images.

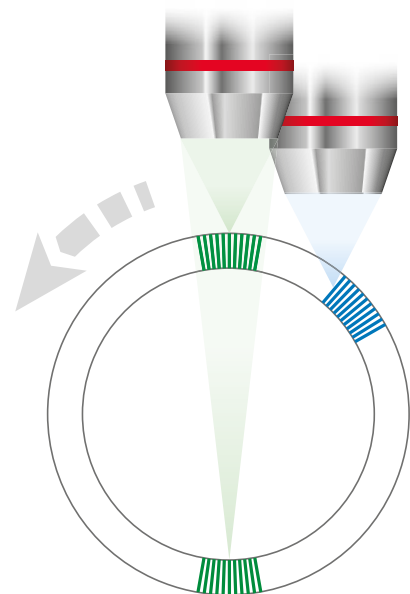

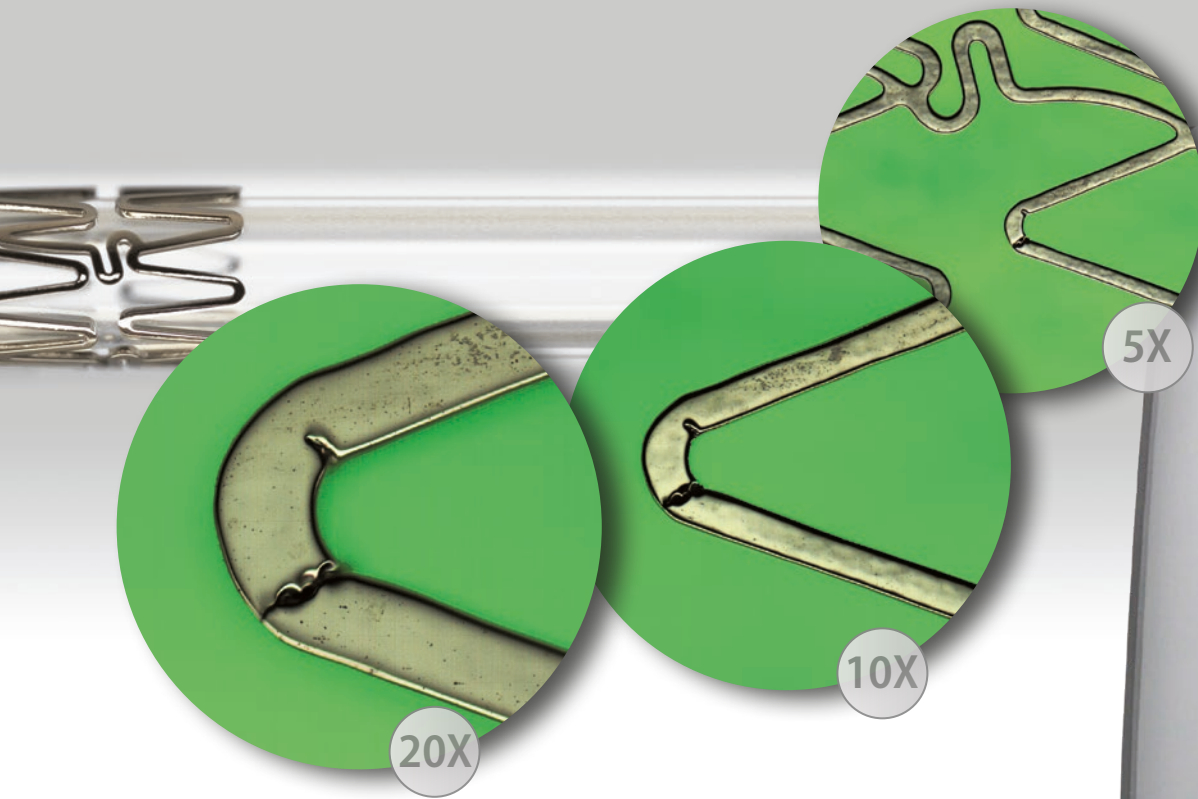

Astonishing high-resolution imaging

Observe the
smallest details

High NA optical design, premium CF60-2 Nikon objectives, a multi-million pixel imaging array and a unique combination of light sources provide extremely sharp views of the complete stent surface with unprecedented real color, resolution and contrast.

A wide-variety of sharp possibilities

Autolight and autofocus features quickly and easily provide sharp, clear images in multiple formats: Live, Screenshot, Extended Focus Field of View (EFOV), Unrolled Field of View (UFOV) and Unrolled Section.



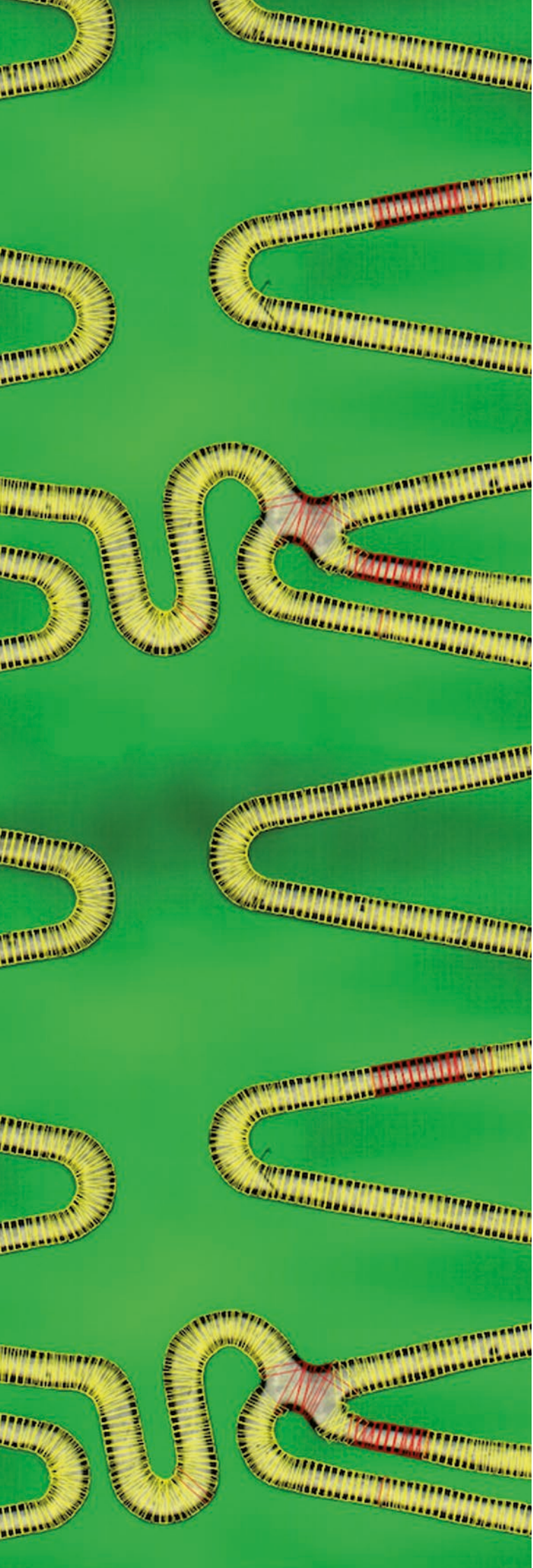

**Accurate
dimensional analysis**

Simultaneous
acquisition
& analysis

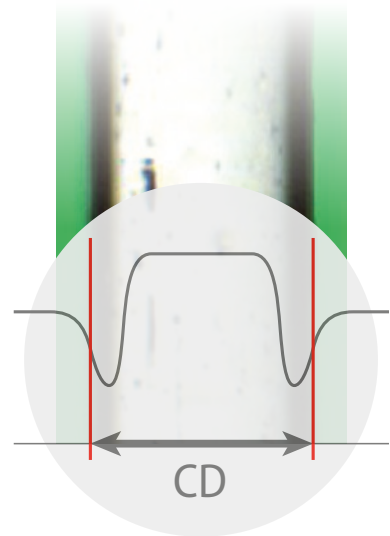

**Extremely high
inspection rate**

UP TO 1 CORONARY
STENT PER 
MINUTE

Critical Dimensions

SensolINSPECT algorithms use sub-pixel resolution to detect the width of the strut. Critical Dimensions can be determined throughout the entire stent structure (CD Full analysis) or in previously defined areas of interest in the Stent Model Database (CD Regions analysis).

Dimensional analysis results are obtained with a repeatability of +/- 1% rms and +/- 3% PV. This information is superimposed onto the unrolled images with a green/red flag that indicates whether the dimensions are in or out of the accepted tolerance range allowing immediate decision-making.

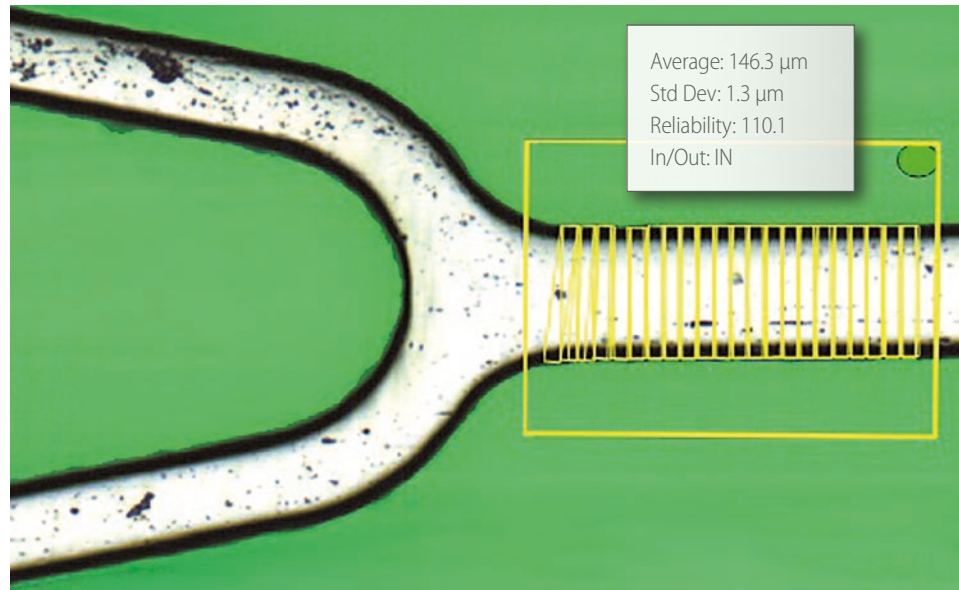

Edges

SensolINSPECT software simultaneously identifies the edges of struts in unrolled images and uses dimensional analysis to provide an accurate assessment of the shape (roundness / sharpness) of these edges.

This kind of analysis can be also carried out throughout the complete stent structure (Edges Full analysis) or in individual areas of interest (Edges Regions analysis).

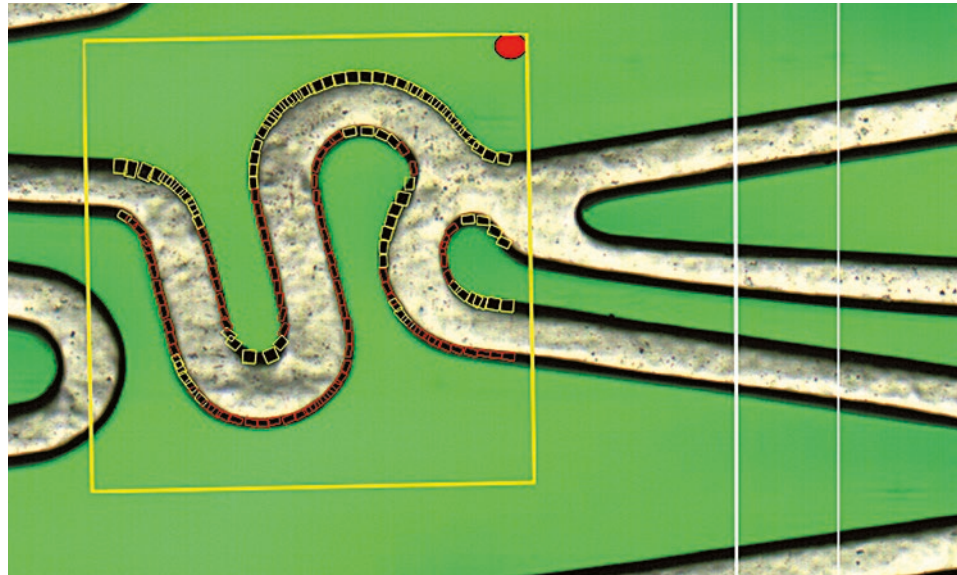

Sidewalls

SensolINSPECT obtains immediate readings of the real size of stent sidewalls by measuring them at every position along the length of the struts displayed in the unrolled section (without applying any geometric correction).

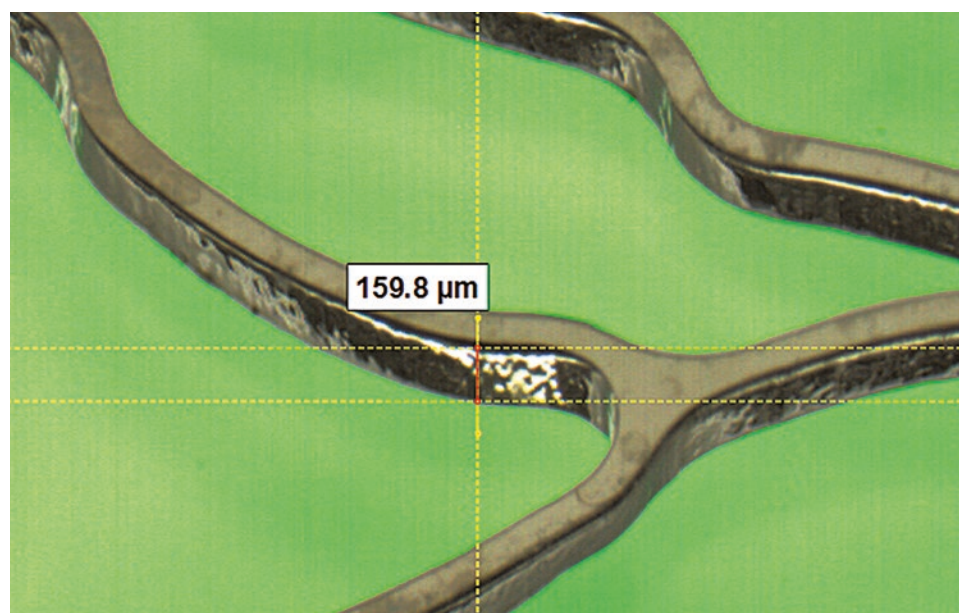



Defect detection and classification

Train your system

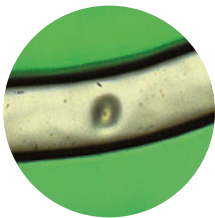

Pitting

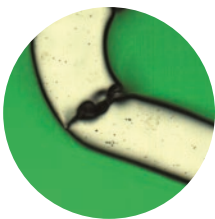

Crack

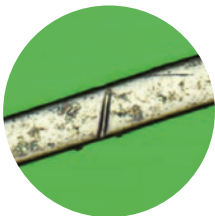

Scoremark



Scratch

Reduce time spent on tedious visual inspections with the Q six. SensolNSPECT detects and classifies surface defects based on a customer-defined defect library and displays the position of each defect on a high-resolution unrolled image. Classification algorithms are easily trained from representative defect images stored in the library.

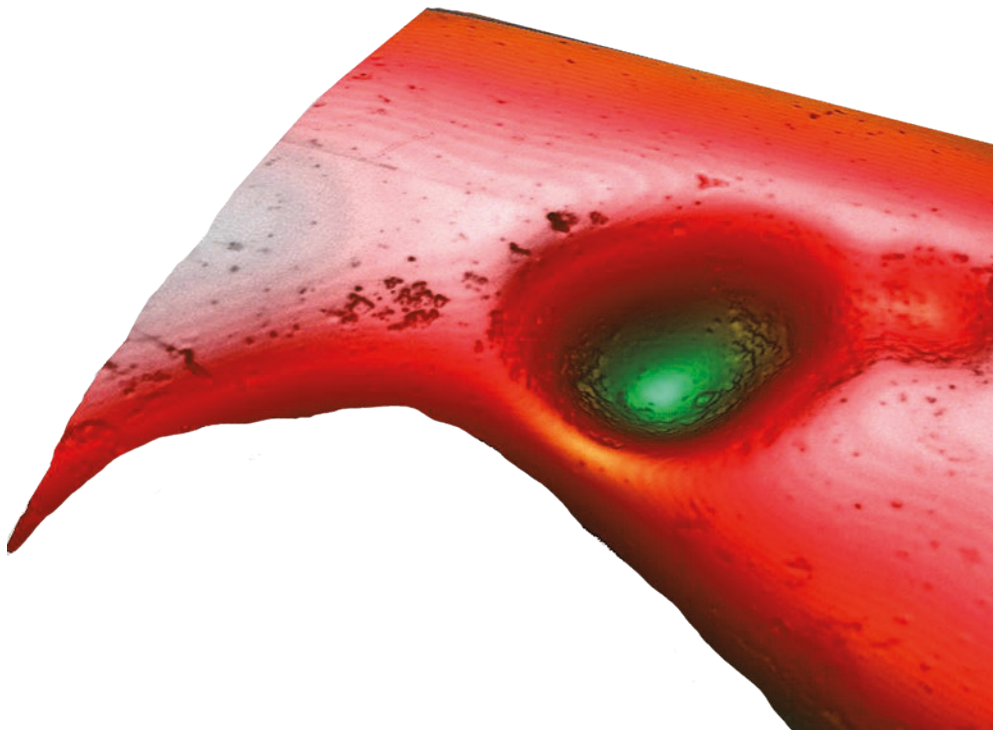

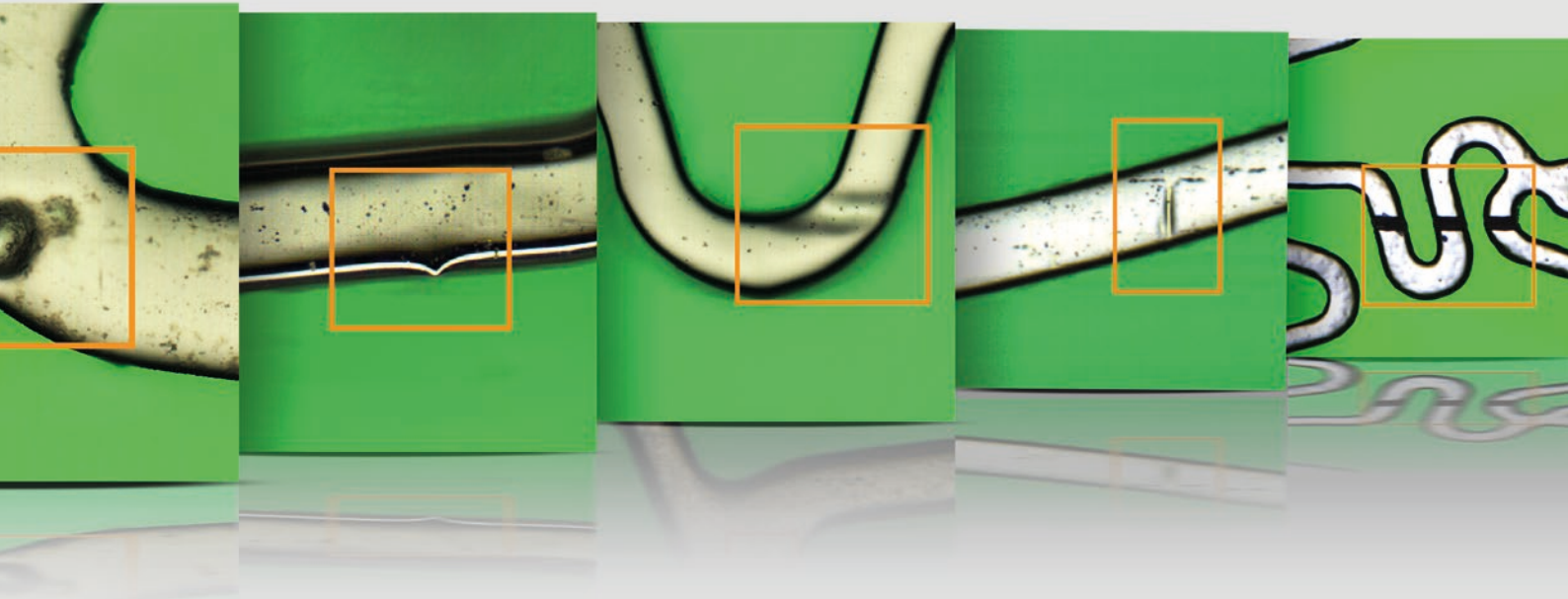

Assisted decisions Accept or reject your stent

SIDEWALLS 8 SECTIONS

- ✓ C. Dim.
- ✓ Edges

1	2	3	4	5	6	7	8
✓	✓	✓	✓	✓	✓	✓	✓
✓	✓	✓	✓	✓	✓	✓	✓

INNER SURFACE 8 SECTIONS

- ✓ C. Dim.
- ✓ Edges

1	2	3	4	5	6	7	8
✓	✓	✓	✓	✓	✓	✓	✓
✓	✓	✓	✓	✓	✓	✓	✓

OUTER SURFACE 8 SECTIONS

- 1 C. Dim.
- ✓ Edges
- 3 Defects

1	2	3	4	5	6	7	8
✓	✓	✓	✓	1	✓	✓	✓
✓	✓	1	✓	2	✓	✓	✓

Operator Admin
 Lot ID LOT1
 Batch ID BATCH1
 Stent ID 2
 Operation Laser cutting and pickling

Stent **ACCEPTED**
 Time: 12-16-2014 18:28:51
 Acquisition started: 12-16-2014 18:24:32

FACE	SECTION	REGION ID	# MATCH	ID MATCH	AVERAGE	STDEV	RELIABILITY
Outer	1	1	1	1	63.669	1.601	39.773
Outer	1	1	1	2	64.417	1.996	32.278
Outer	1	1	2	1	64.158	2.258	28.417
Outer	1	1	2	2	63.954	1.726	37.045
Outer	1	1	3	1	62.372	1.243	60.184
Outer	1	1	3	2	65.040	1.752	37.126
Outer	1	1	4	1	64.271	0.915	70.234
Outer	1	1	4	2	63.576	2.494	25.495
Outer	1	1	5	1	63.507	1.532	41.452
Outer	1	1	5	2	66.290	2.468	28.858
Outer	1	1	6	1	61.343	1.515	40.480
Outer	1	1	6	2	62.854	2.091	30.062
Outer	1	1	7	1	64.889	0.908	71.433
Outer	1	1	7	2	64.499	1.722	37.451
Outer	1	2	1	1	102.014	1.403	72.693
Outer	1	2	2	1	101.997	2.265	45.029
Outer	1	2	3	1	100.006	0.911	120.372
Outer	1	2	4	1	97.553	0.906	105.377
Outer	1	2	5	1	100.973	0.908	112.409
Outer	1	2	6	1	98.367	1.120	88.929

Operators using the Q six in the assisted mode easily undertake accurate and reliable decisions for acceptance. If necessary, the operator can immediately navigate back to any position on the surface to review dimensional results, observe potential defects in more detail using higher magnification objectives or even perform additional analysis using 3D modes. Stent Inspection Results will be transferred to the Production ERP, making the inspection process traceable.

Report and save stent inspection results

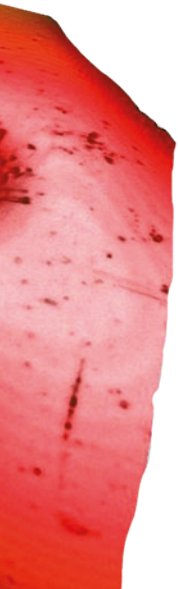

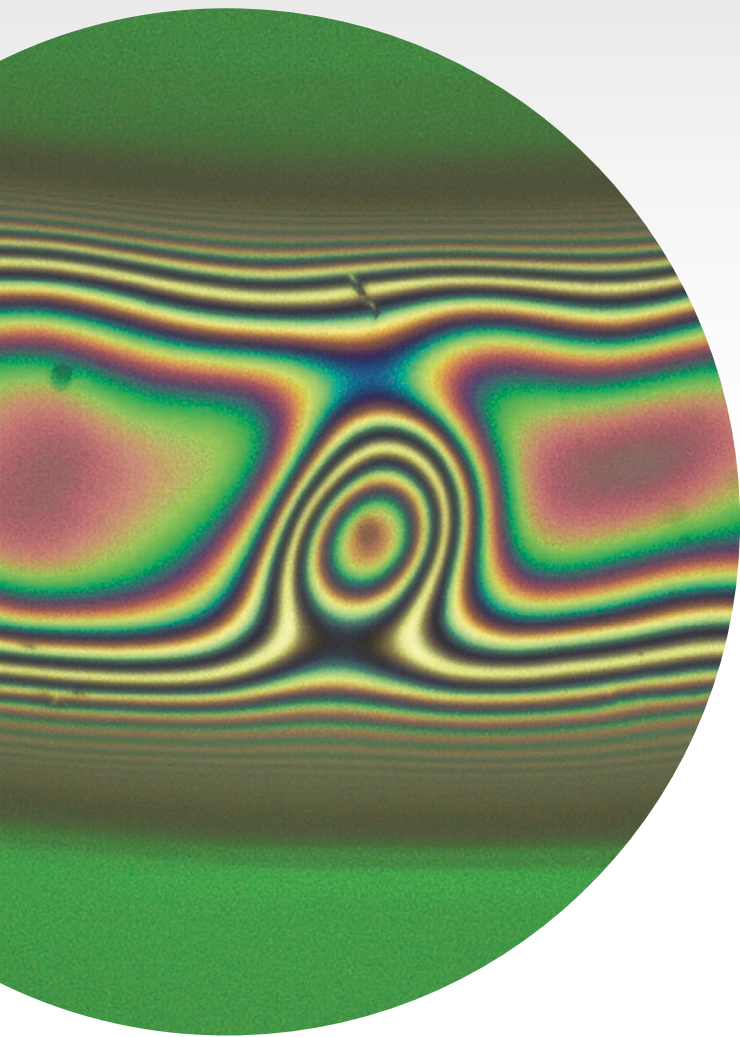

3D modes

Overcoming the limits of 2D Imaging

Non-contact optical 3D profiling using Sensofar's proven Vertical Scanning Interferometry (VSI) technology.

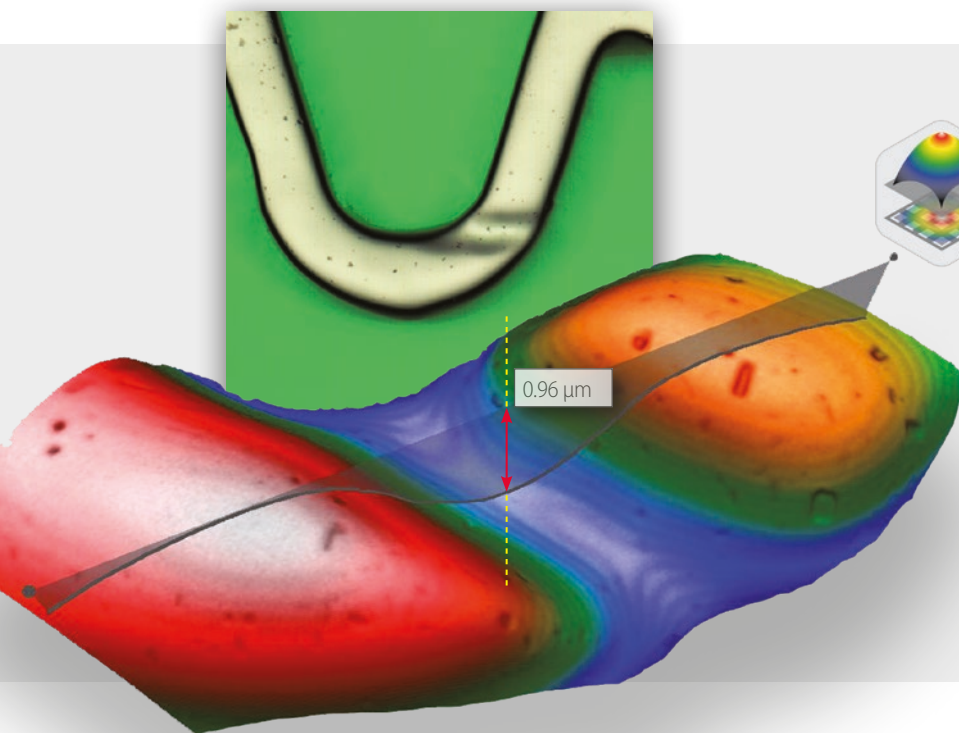

Surface topography

Verify the depth of scoremarks or scratches of your stents. 3D Topography of a defect can be obtained in seconds with a lateral resolution of 0.5 μm and a vertical resolution of 1nm.

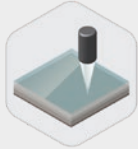
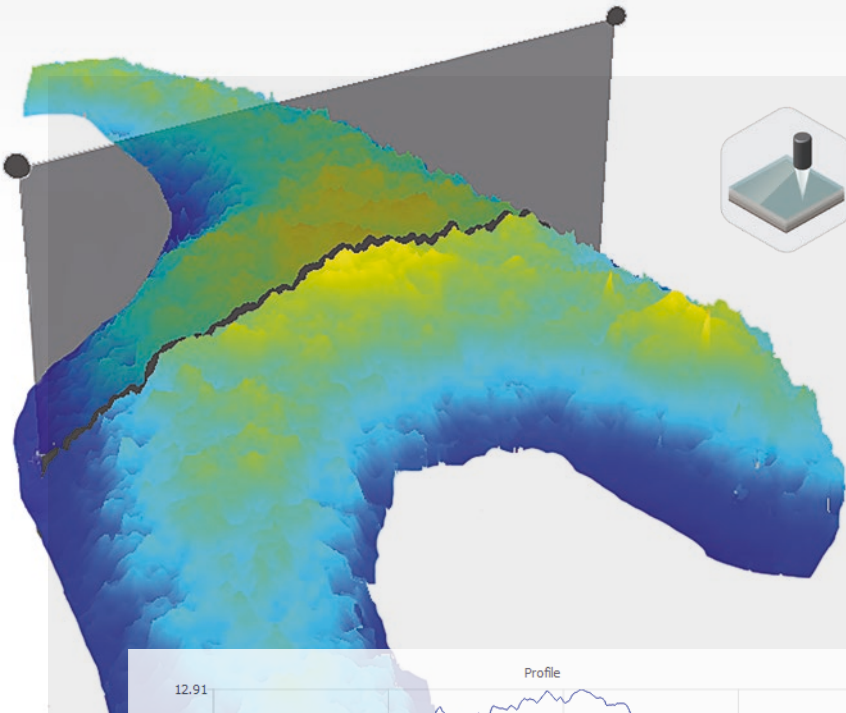

Mapping the thickness of coatings

Check the performance of your process and coating uniformity. Thickness of optically transparent coatings is mapped all across the width of the struts with a lateral resolution of 0.5 microns and a vertical resolution of 2 nm in just a few seconds. The minimum value of the thickness that can be measured is approximately 2 microns.

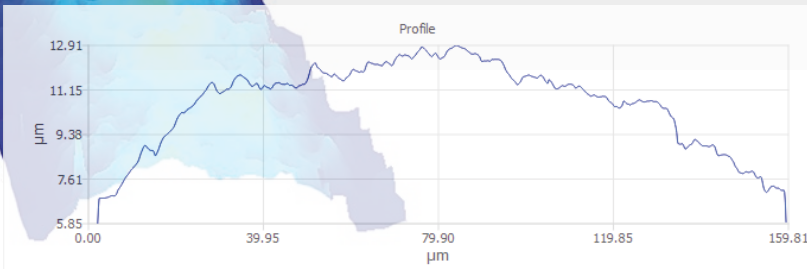

Surface roughness

Check the quality of your electro-polishing process. Standard surface texture parameters are measured according to ISO 25178. The operator can select areas of measurement at the outer surface of the stent and filtering parameters.



Parameter	Value	Units
Area	0.0503	mm ²
Sa	0.1221	µm
Sq	0.1621	µm
Sp	2.5431	µm
Sv	1.6531	µm
Sz	4.1961	µm
Skk	-0.9053	
Sku	7.3940	

State of the art technology

Designed with you in

The new generation of dedicated tools
for the inspection of medical devices

Advanced illumination control Up. Down. Lateral.

The unique combination of three independent light sources (Epi white, Back green and Side white) offers the best illumination settings for each kind of imaging conditions. The cold light provided by LED technology does not affect stent materials and coatings. Long LED lifetime reduces maintenance costs for the Q six.

Customized mandrels option Designed to fit your stents

Mandrel fixtures are available as a customized solution for positioning stents with low stiffness. These mandrels are based on transparent thin-walled glass tubes. Mandrels do not affect the quality of the images or the results of the dimensional analysis.



mind

High-accuracy positioning stage

The roller stage is a modular component of the Q six. Individual stents are manually loaded on the roller stage in the inspection position. All motion is motorized under complete software control, including X/Z translation and 360° rotation. The user can navigate through manual control or create a completely automatic recipe to scan the stent surfaces. Position accuracy of the stage is within 1 μm at any point on the surface of the stent.

Niko
Plan Fi
5X/0.15 A
DFN25 WD23.5 MUE125

Data management

Depending on the intended use, the Q six can be operated in three different environments: Development, Quality Assurance (QA) and Production. Each environment has its own databases.

Data is organized in three different categories:

- 1 System Databases containing User data and System configuration files
- 2 Stent Inspection Databases containing Stent Model data, Defect libraries and Acquisition, Analysis and Report recipes
- 3 Inspection Results

Validation package

Sensofar Medical can provide specialized support to QA/RA departments in qualification and validation processes. A complete validation package for the Q six is available as an option.

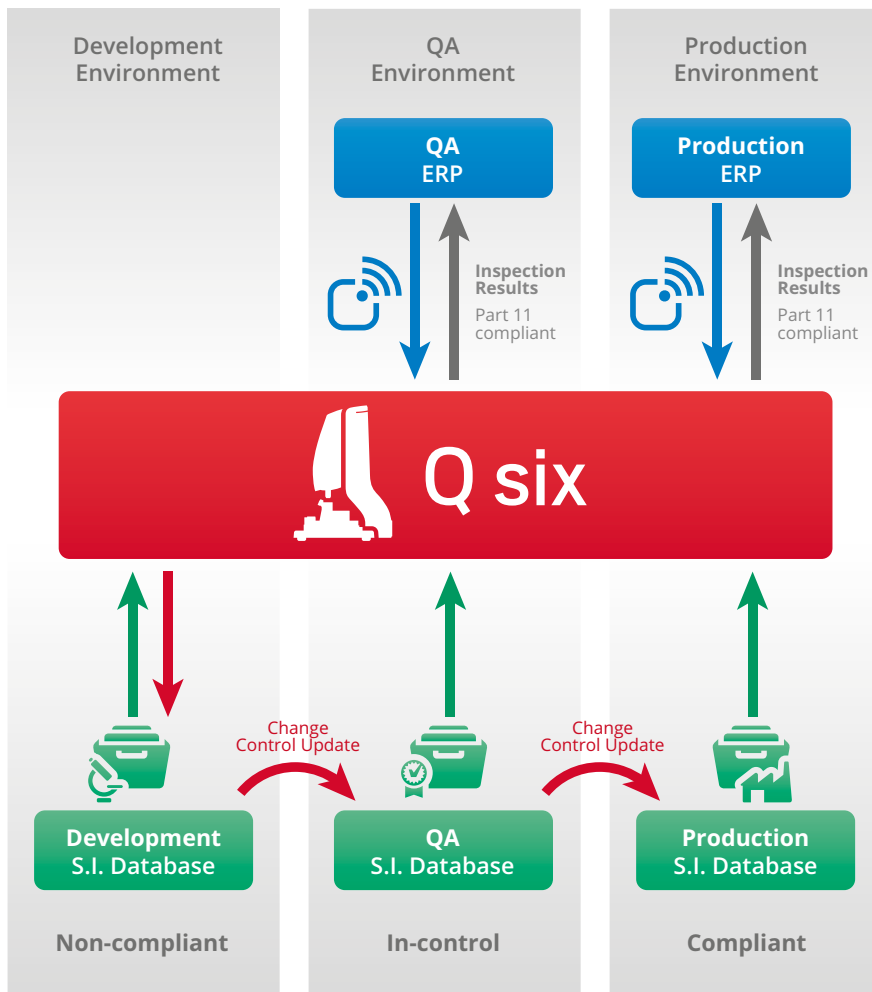

Objectives

	Imaging Objectives				3D Objectives		
Magnification	2.5X	5X	10X	20X	10XDI	20XDI	50XDI
NA	0.08	0.15	0.20	0.45	0.30	0.40	0.55
WD (mm)	8.80	23.50	37.00	4.50	7.40	4.70	3.40
Horizontal FOV (mm)	7.20	3.60	1.80	0.90	1.80	0.90	0.36
Spatial sampling (μm) ¹	3.52	1.76	0.88	0.44	0.88	0.44	0.18
Optical resolution (μm) ²	1.95	0.97	0.73	0.32	0.48	0.36	0.26
Acquisition time (mm ² /s)	20	5	1.25	0.31	-		
Vertical resolution (nm) ³	-				1		

- 1** Pixel size on the surface
- 2** L&S: Line and Space, half of the diffraction limit according to the Rayleigh criterion (values for green LED)
- 3** Values obtained under vibration isolation conditions

System specifications

Stent material	Metal (Stainless Steel, CoCr) and Nitinol
Stent OD	1 - 15 mm
Stent length	Up to 100 mm (XL stage option 200 mm)
Measurement array	Color 2044 x 1084 effective pixels
LED light sources	white (EPI and side) and green (530 nm) (back)
Imaging modes	Live image, screenshot, unrolled FOV and unrolled section
Inspection capabilities	Outer surface, inner surface, sidewalls, edges
CD measurement repeatability	+/- 1% rms
CD measurement accuracy	+/- 3% PV
Surface inspection	Automatic defect detection and classification
3D modes	Surface topography, Roughness, Thickness of coatings
Assisted concept	Acceptance decision made by the operator
Computer	iMac; 2560 x 1440 pixels resolution (27")
Operating system	Microsoft Windows 8, 64-bit
Electrical requirements	Line Voltage 100-240 V AC; frequency 50/60 Hz single phase

Dimensions unit: mm

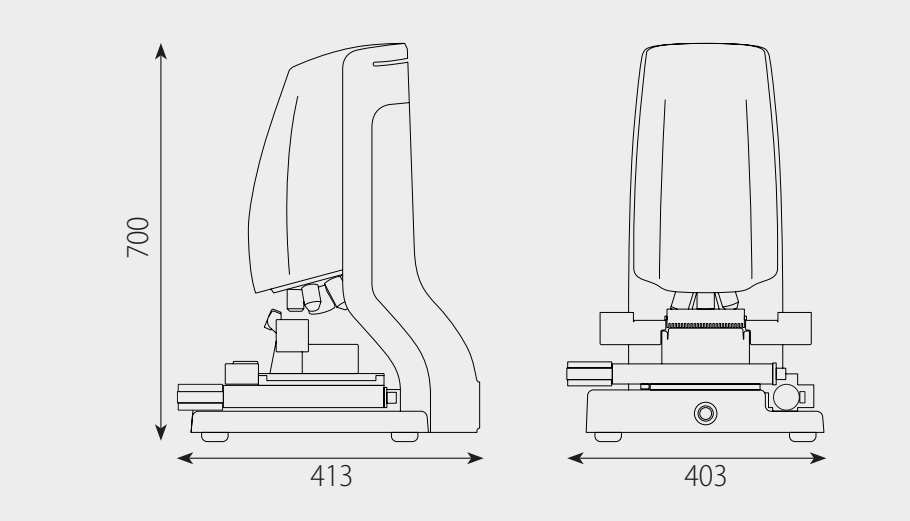



SENSOFAR is a leading-edge technology company that has the highest quality standards within the field of surface metrology

Sensofar Medical provides state-of-the-art technology for the inspection of implantable medical devices and components as well as leading-edge solutions for R&D worldwide, with each system designed to incorporate the highest quality standards within the field.

The Sensofar Group headquarters are located in Barcelona, the technological heart of Spain. The Group is represented in over 20 countries through a global network partners and has its own offices in Asia, Germany and the United States.

HEADQUARTERS

SENSOFAR MEDICAL | BARCELONA (Spain) | T. +34 93 700 14 92 | info@sensofar.com

SALES OFFICES

SENSOFAR ASIA | SHANGHAI - China | T. +86 21 61400058 | info.asia@sensofar.com

SENSOFAR USA | NEWINGTON (CT) - USA | T. +1 617 678 4185 | info.usa@sensofar.com

sensofar.com